

PAC344-OD/2.8 2 MP Ultra-Low Light Dome Camera



Key Features

- 2 MP high performance COMS
- Ultra-low light
- 1920 × 1080 resolution
- 2.8 mm fixed focal lens
- 130 dB true WDR, 3D DNR
- EXIR 2.0, smart IR, up to 30 m IR distance
- 4 in 1 video output (switchable TVI/AHD/CVI/CVBS)
- IP67, IK10
- Up the coax

Specification

Camera	
Image Sensor	2.0 megapixel progressive scan CMOS
Signal System	PAL/NTSC
Frame Rate	PAL: 1080p@25fps NTSC: 1080p@30fps
Resolution	1920 (H) × 1080 (V)
Min. illumination	Color: 0.003 Lux @ (F1.2, AGC ON), 0 Lux with IR
Shutter Time	PAL: 1/25 s to 1/50, 000 s NTSC: 1/30 s to 1/50, 000 s
Lens	2.8 mm
Horizontal Field of View	104° (2.8 mm)
Lens Mount	M12
Day & Night	IR cut filter
WDR (Wide Dynamic Range)	≥ 130 dB
Angle Adjustment	Pan: 0° to 355°, Tilt: 0° to 75°, Rotate: 0° to 355°
Menu	
Image Mode	STD/HIGH-SAT
AGC	Support
Day/Night Mode	Auto/Color/BW (Black White)
White Balance	Auto/Manual
AE (Auto Exposure) Mode	WDR/BLC/HLC/Global
Privacy Mask	4 programmable privacy masks
Motion Detection	4 programmable motion areas
NR (Noise Reduction)	3D/2D
Language	English
Functions	Brightness, Sharpness, Mirror, Smart IR, HLC
Interface	
Video Output	Switchable TVI/AHD/CVI/CVBS
General	
Operating Conditions	-40 °C to 60 °C (-40 °F to 140 °F), humidity: 90% or less (non-condensation)
Power Supply	12 VDC ±25% <i>*You are recommended to use one power adapter to supply the power for one camera.</i>
Power Consumption	Max. 3.4 W
Protection Level	IP67, IK10
Material	Metal
IR Range	Up to 30 m
Communication	Up the coax, Protocol: HIKVISION-C (TVI output)
Dimensions	Φ 110.8 mm × 84.7 mm (Φ 4.4" × 3.3")
Weight	Approx. 492 g (1.08 lb.)

Order Models

PAC344-OD/2.8

Dimension

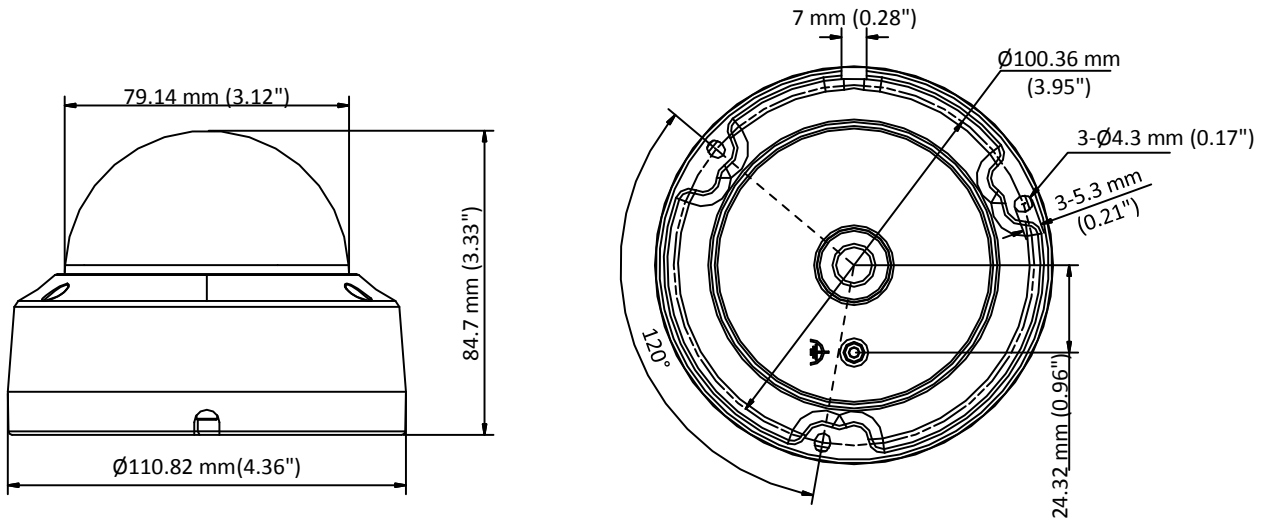

Accessory

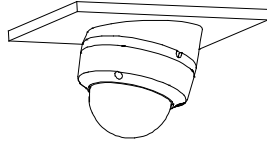

P-259ZJ
Inclined Ceiling Mount

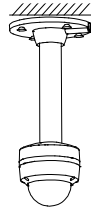

P-271ZJ-110
Pendant Mount

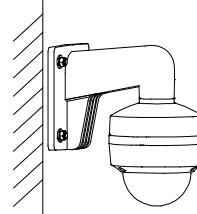

P-272ZJ-110B
Wall Mount

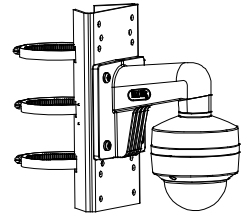

P-275ZJ
Vertical Pole Mount

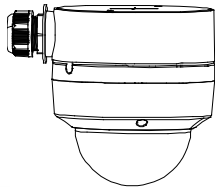

P-280ZJ-DM18
Junction Box

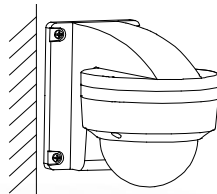

P-258ZJ
Wall Mount